



+AMERICAN RIVER INOX

+AMERICAN TUBE INOX

+SQUARE INOX

+TECNO INOX

+JOLLY INOX

+BIG BOX INOX

+PANEL RIVER INOX

+PANEL TUBE INOX

+ORIENTE INOX







BOND
BOND

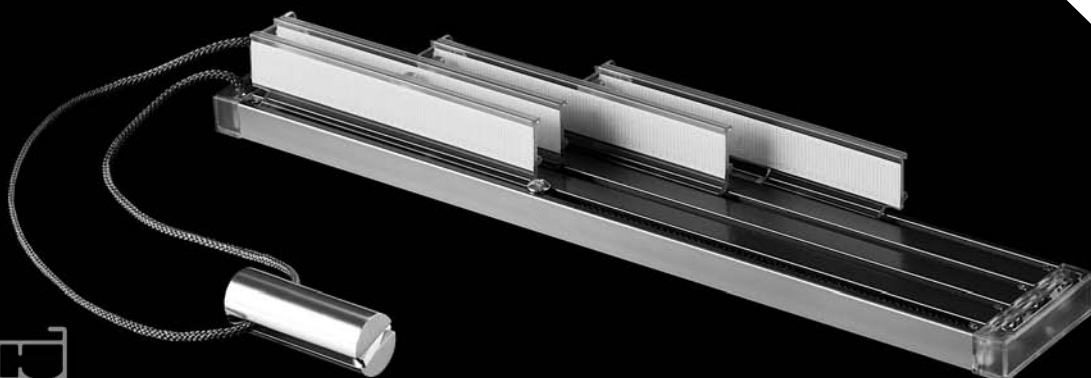



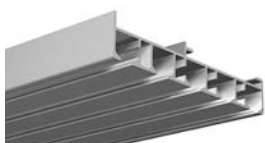

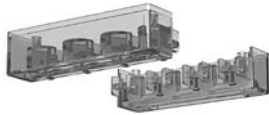



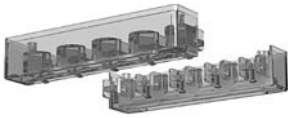





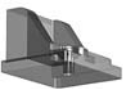













SCALA 1:2





	+CODICE CODE	+DESCRIZIONE DESCRIPTION	+IMBALLO PACKING
	PB 003.00X	Binario a 3 vie, inox, m. 6 3 Ways rail, inox, m. 6	m/m 60
	PB 004.00X	Binario a 4 vie, inox, m. 6 4 Ways rail, inox, m. 6	m/m 60
	PB 005.00X	Binario a 5 vie, inox, m. 6 5 Ways rail, inox, m. 6	m/m 30
	PM 030.006	Coppia testate guida corda a 3 vie, trasparente Pair of cord pulleys for 3 ways, transparent	cp/pair 50
	PM 031.00X	Coppia testate guida corda a 3 vie con ruote, cromato Pair of cord pulleys for 3 ways with wheels, chrome covered	cp/pair 50
	PM 040.006	Coppia testate guida corda a 4 vie, trasparente Pair of cord pulleys for 4 ways, transparent	cp/pair 50
	PM 041.00X	Coppia testate guida corda a 4 vie con ruote, cromato Pair of cord pulleys for 4 ways with wheels, chrome covered	cp/pair 50

	+CODICE CODE	+DESCRIZIONE DESCRIPTION	+IMBALLO PACKING
	PM 050.006	Coppia testate guida corda a 5 vie, trasparente Pair of cord pulleys for 5 ways, transparent	cp/pair 50
	PM 051.00X	Coppia testate guida corda a 5 vie con ruote, cromato Pair of cord pulleys for 5 ways with wheels, chrome covered	cp/pair 50
	PT 030.006	Coppia tappi a 3 vie, trasparente Pair of end caps for 3 channels, transparent	cp/pair 50
	PT 040.006	Coppia tappi a 4 vie, trasparente Pair of end caps for 4 channels, transparent	cp/pair 50
	PT 050.006	Coppia tappi a 5 vie, trasparente Pair of end caps for 5 channels, transparent	cp/pair 50
	PA/T 200.346	Angolare a "T" per PV 234.006, trasparente "T" shaped angle for PV 234.006, transparent	pz/pc 100
	PA/L 201.346	Angolare a "L" per PV 234.006, trasparente "L" shaped angle for PV 234.006, transparent	pz/pc 100
	PA/T 203.346	Angolare a "T" per PN 234.006, trasparente "T" shaped angle for PN 234.006, transparent	pz/pc 100
	PA/L 204.346	Angolare a "L" per PN 234.006, trasparente "L" shaped angle for PN 234.006, transparent	pz/pc 100
	AU 830.005	Giunzione per corda Cord fixing device	pz/pc 100

	+CODICE CODE	+DESCRIZIONE DESCRIPTION	+IMBALLO PACKING
	PU 830.005	Giunzione per corda con viti Cord fixing device with screws	pz/pc 100
	PA 830.005	Giunzione per corda Cord fixing device	pz/pc 100
	PQ 400.000	Vite di arresto Stop-screw	pz/pc 100
	PV 234.006	Barra velcrata in pvc, trasparente, m. 4 Pvc velcro bar, transparent, m. 4	m/m 120
	PV 234.003/A	Barra velcrata in pvc, argento, m. 4 Pvc velcro bar, silver, m. 4	m/m 120
	PV 234.005/N	Barra velcrata in pvc, nera, m. 4 Pvc velcro bar, black, m. 4	m/m 120
	PN 234.006	Barra in pvc, trasparente, m. 4 Pvc bar, transparent, m. 4	m/m 120
	PS 345.001	Chiavetta per binari a 3-4-5 vie con rondella in ferro Key for 3-4-5 ways rail with iron washer	pz/pc 100
	RS 234.005	Adattatore Adapter	pz/pc 100
	PR 100.001	Rullino tornito in delrin Lathed traveller in delrin	pz/pc 1000

	+CODICE CODE	+DESCRIZIONE DESCRIPTION	+IMBALLO PACKING
	PR 100.00X	Rullino acciaio inossidabile con cuscinetto a sfera Stainless steel ball bearing runner	pz/pc 500
	EM 130.006	Comando fermacorda, trasparente Cord lock, transparent	pz/pc 100
	EM 592.006	Passante cordino con spina, trasparente Metal folding curtain loop, transparent	pz/pc 300
	AC 010.006	Cordone, grigio, mm. 1 Cord, grey, mm. 1	m/m 500
	AC 035.006	Cordone, grigio, mm. 3,5 Cord, grey, mm. 3,5	m/m 500
	PG 000.345	Giunzione per binari 3-4-5 vie Join for 3-4-5 channels track	pz/pc 10
	AF 111.006	Tendicorda con peso, trasparente, gr. 100 Cord weight, transparent, gr. 100	pz/pc 100
	AF 112.006	Tendicorda con peso, trasparente, gr. 90 Cord weight, transparent, gr. 90	pz/pc 100
	PP 025.005	Piattina bianco m. 6 _ H cm. 2,5 _ P cm. 0,4 Weight white m. 6 _ H cm. 2,5 _ P cm. 0,4	m/m 150
	PP 030.005	Piattina bianco m. 6 _ H cm. 3,0 _ P cm. 0,4 Weight white m. 6 _ H cm. 3,0 _ P cm. 0,4	m/m 120
	PP 040.005	Piattina bianco m. 6 _ H cm. 4,0 _ P cm. 0,4 Weight white m. 6 _ H cm. 4,0 _ P cm. 0,4	m/m 90

	+CODICE CODE	+DESCRIZIONE DESCRIPTION	+IMBALLO PACKING
	PZ 001.005	Ammortizzatore Damper	pz/pc 1000
	TP 025.006	Tappo piattina, trasparente, H. cm. 2,5 Transparent end cap for weight, H. cm. 2,5	pz/pc 200
	TP 030.006	Tappo piattina, trasparente, H. cm. 3 Transparent end cap for weight, H. Cm. 3	pz/pc 200
	TP 040.006	Tappo piattina trasparente, H. cm. 4 Transparent end cap for weight, H. cm. 4	pz/pc 200
	PF 100.006	Asta guidatenda, trasparente m. 1 Crystal clear curtain guide rod m. 1	pz/pc 10
	PF 125.006	Asta guidatenda, trasparente m. 1,25 Crystal clear curtain guide rod m. 1,25	pz/pc 10
	PF 150.006	Asta guidatenda, trasparente m. 1,50 Crystal clear curtain guide rod m. 1,50	pz/pc 10



Galtex Lines srl

via Liguria 20 - 60030 Monsano An Italy - tel +39 0731 60151 - fax +39 0731 619811 - info@carmeli.it - www.carmeli.it